

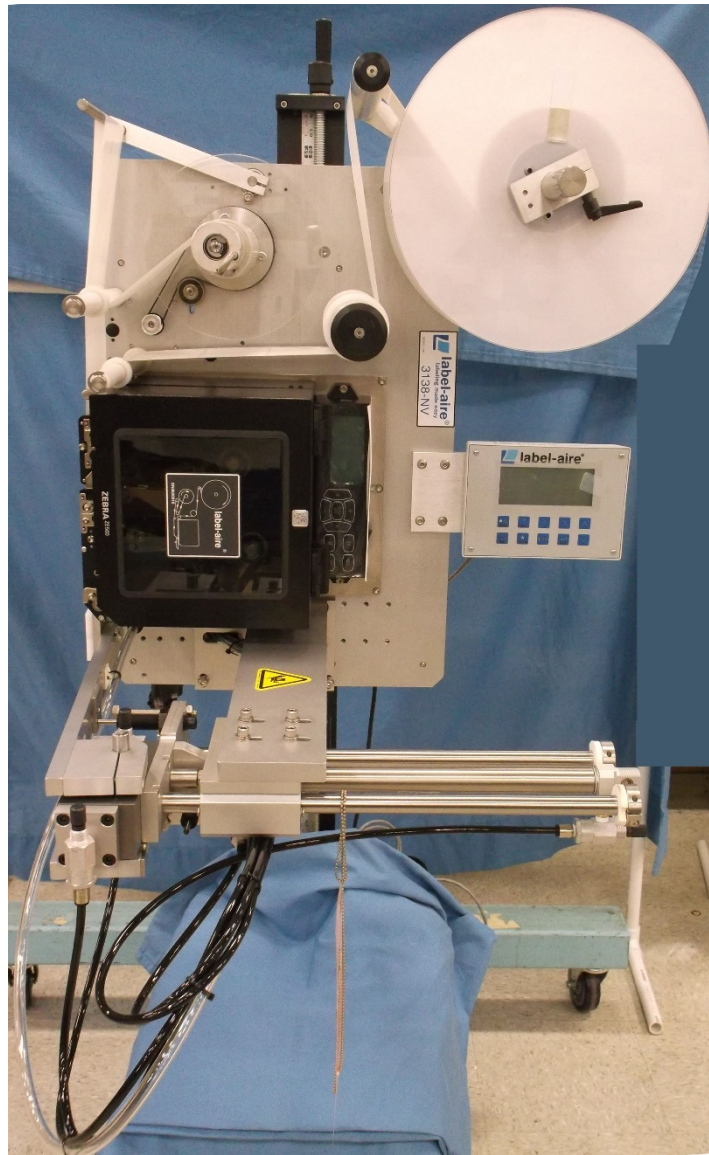



M236000

3138NV-DAT-ZE543 RH 12" REACH



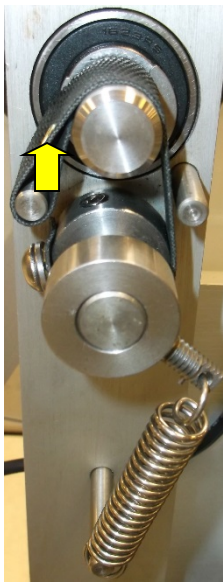





SPARE PARTS CATALOG

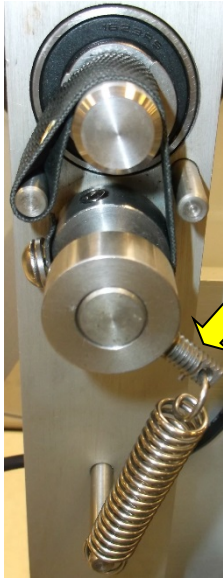

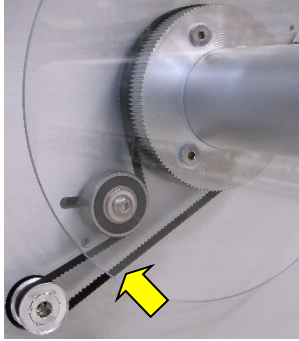

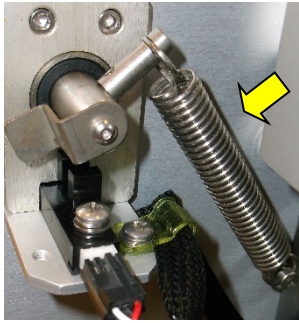

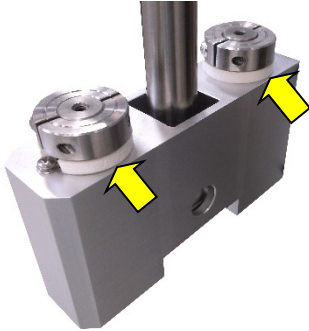

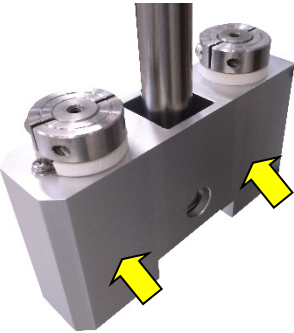

LABEL-AIRE

M236000-3138NV SPARE PARTS WEAR ITEMS					
NO	PART NO.	DESCRIPTION	QTY	ASSEMBLY PHOTO	DETAIL PHOTO
1	7440700	ASY BRAKE BAND	1		
2	7700254	BRAKE SPRING	1		

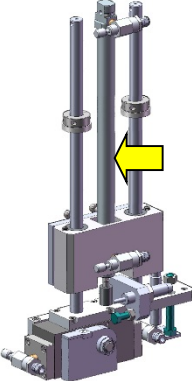

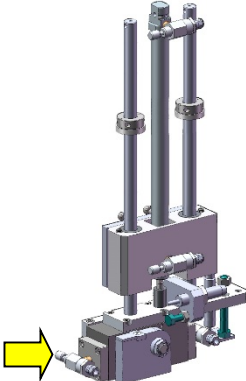

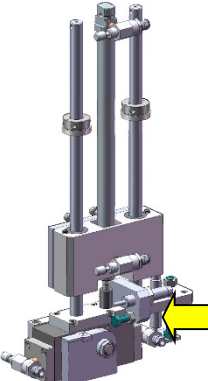
**M236000-3138NV SPARE PARTS
WEAR ITEMS**

NO	PART NO.	DESCRIPTION	QTY	ASSEMBLY PHOTO	DETAIL PHOTO
3	7440960	ANCHOR SPRING 1/4-20 X 0.875	1		
4	7702959	REWIND BELT 168MXL025	1		
5	7701787	REWIND SPRING	1		
6	V243058	PAD STOP FELT VARIABLE STROKE TAMP	2		

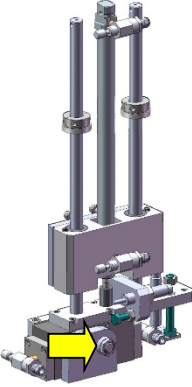

**M236000-3138NV SPARE PARTS
WEAR ITEMS**

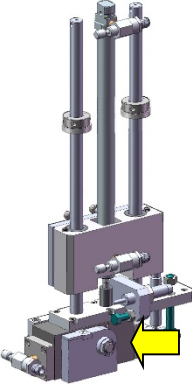
NO	PART NO.	DESCRIPTION	QTY	ASSEMBLY PHOTO	DETAIL PHOTO
7	7703335	BRG LINEAR 0.625 X 1.500LG	4		
8	7701773	CYL 20MM BORE 250MM ST ISO	1		
9	7452400	VALVE FLOW CNTRL 1/8 NPT	4		
10	7700607	SHOCK ABSORBER MC150	2		





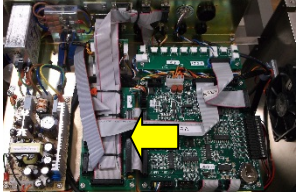
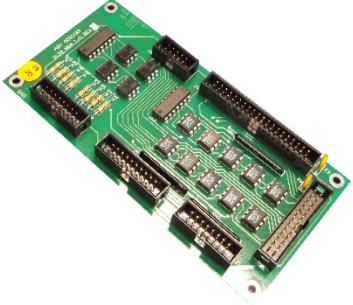
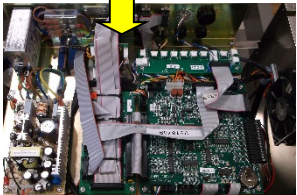
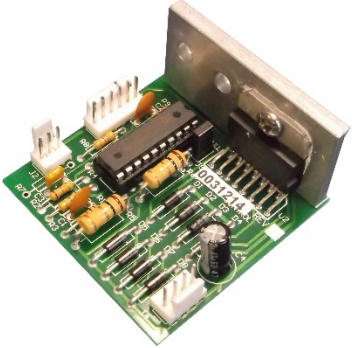
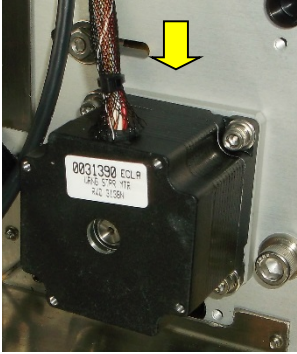
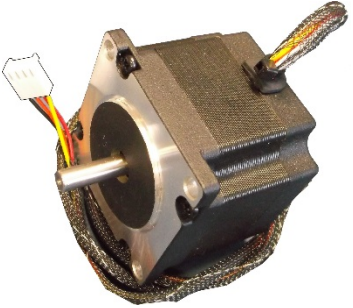
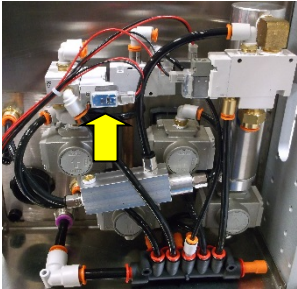

**M236000-3138NV SPARE PARTS
WEAR ITEMS**

NO	PART NO.	DESCRIPTION	QTY	ASSEMBLY PHOTO	DETAIL PHOTO
11	7707330	TRANTORQ .500 ID .875 OD MINI	1		
12	7701326	ACTUATOR RTRY 135	1		

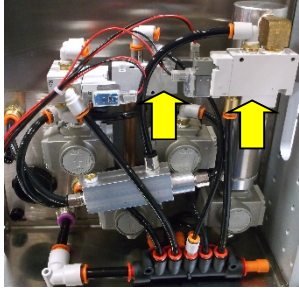
**M236000-3138NV SPARE PARTS
CIRCUIT BOARDS & ELECTRICAL**

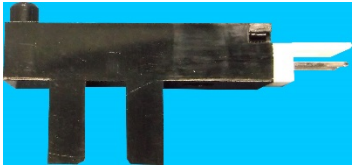
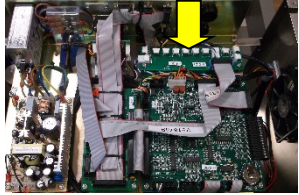
NO	PART NO.	DESCRIPTION	QTY	ASSEMBLY PHOTO	DETAIL PHOTO
13	0031183	ASY 3138 NGA I/O CARD	1	 An assembly photo showing a green printed circuit board (PCB) installed in a rack. A yellow arrow points to the board.	 A detail photo of the green PCB, showing various electronic components like integrated circuits, resistors, and connectors.
14	0031214	ASY REWIND CARD	1	 An assembly photo showing a green PCB installed in a rack. A yellow arrow points to the board.	 A detail photo of the green PCB, showing various electronic components like integrated circuits, resistors, and connectors.
15	0031390	ASY/WRNG STPR MTR RWD	1	 An assembly photo showing a black motor unit mounted on a metal panel. A yellow arrow points to the motor.	 A detail photo of the motor unit, showing its cylindrical shape and electrical connections.
16	7702262	CONNECTOR 1M VALVES (USED WITH VALVE 7702207)	1	 An assembly photo showing a connector assembly with multiple wires connected to valves. A yellow arrow points to the connector.	 A detail photo of the connector assembly, showing the wires and the connector housing.

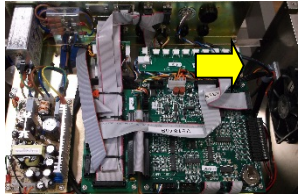

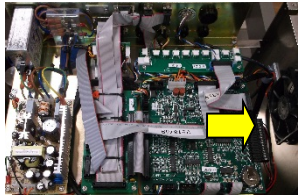
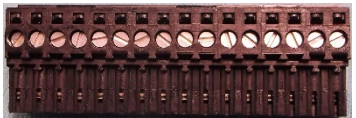

**M236000-3138NV SPARE PARTS
CIRCUIT BOARDS & ELECTRICAL**

NO	PART NO.	DESCRIPTION	QTY	ASSEMBLY PHOTO	DETAIL PHOTO
17	7702263	CONNECTOR 1M SY VALVES (USED WITH VALVES 7702208 AND 7702209)	2		
18	9010527	SENS GAP IR .375 THROAT OMRON	1		
19	V518797	ASY SENSOR DISTRIBUTION BOARD WITH STATIC PROTECTION	1		
20	0031389	ASY/WRNG FAN W/LEADS/PIN	1		
21	9800011	CNCTR CBL 16PIN	1		

**M236000-3138NV SPARE PARTS
CIRCUIT BOARDS & ELECTRICAL**

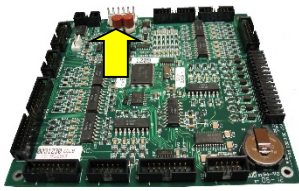
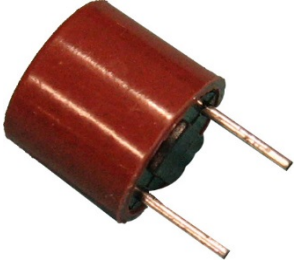
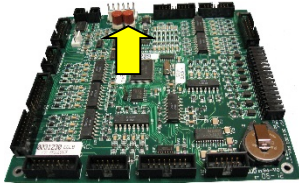
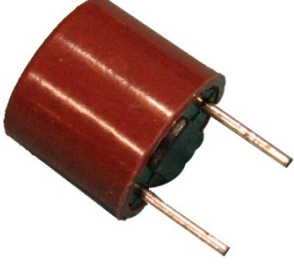
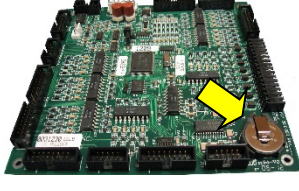
NO	PART NO.	DESCRIPTION	QTY	ASSEMBLY PHOTO	DETAIL PHOTO
22	9051203	POWER CABLE	1		
23	9031285SP	CNCTR PWR IEC 6A FLTR 2 FUSE (FUSES NOT INCLUDED)	1		
24	9022424	FUSE 6.30A 250V 5X20MM T SB	2		
25	DN0021011	DECAL 120V AC ONLY	1		
26	0031240SP	ASY PROCESSOR FUSED	1		

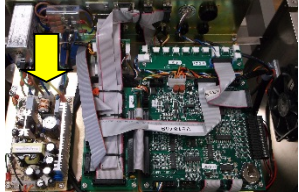
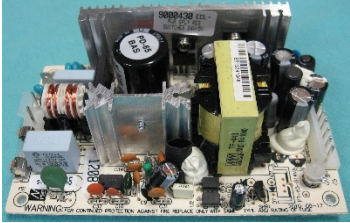
**M236000-3138NV SPARE PARTS
CIRCUIT BOARDS & ELECTRICAL**

NO	PART NO.	DESCRIPTION	QTY	ASSEMBLY PHOTO	DETAIL PHOTO
27	9022498	FUSE 24V 2 amp M/FUSE CONTROL BOARD LOCATION: F2	1		
28	9022496	FUSE 5V 1amp SB M/FUSE CONTROL BOARD LOCATION: F1	1		
29	9000109	BATTERY CR2032 3.0V	1		
30	9000430AP	PWR SPLY REG SWITCHER 24V/5V	1		
31	7600005802 AP	SENS RETRO 10- 30VDC RED	2		

**M236000-3138NV SPARE PARTS
CIRCUIT BOARDS & ELECTRICAL**

NO	PART NO.	DESCRIPTION	QTY	ASSEMBLY PHOTO	DETAIL PHOTO
32	0031186SP	ASY/WRNG LOW LABEL	1		
33	3305080SP	ASY DISPLAY CNTRL PANEL (INCLUDES KEYPAD, DISPLAY, BOARD & CABLE)	1		
34	3306247	DISPLAY CONTROL BOX	1		
35	0031253	ASY STACK LIGHT	1		



**M236000-3138NV SPARE PARTS
CIRCUIT BOARDS & ELECTRICAL**

NO	PART NO.	DESCRIPTION	QTY	ASSEMBLY PHOTO	DETAIL PHOTO
36	7701356	LGT STK 50MM REPLACEMENT LAMP	3		
37	7701353	LGT STK 50MM GRN MOD STDY	1		
38	7701355	LGT STK 50MM AMBER MOD STDY	1		





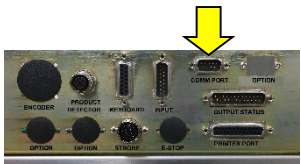
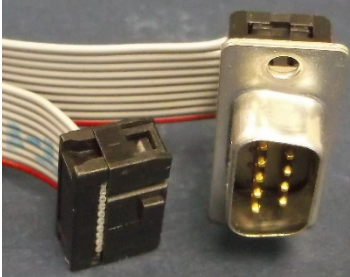
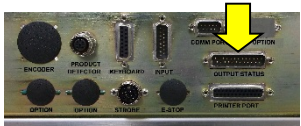

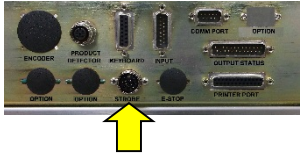
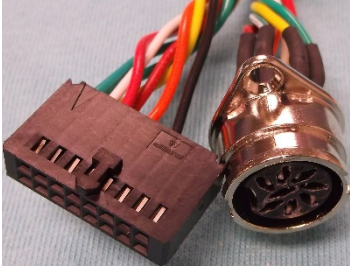
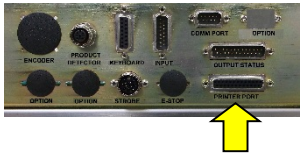
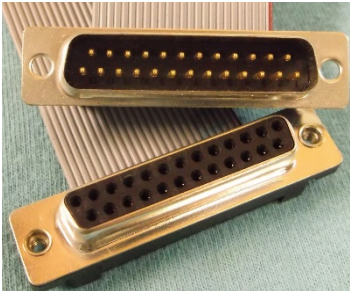
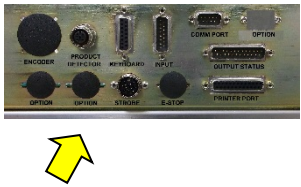
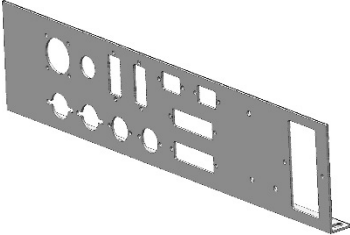

**M236000-3138NV SPARE PARTS
CIRCUIT BOARDS & ELECTRICAL**

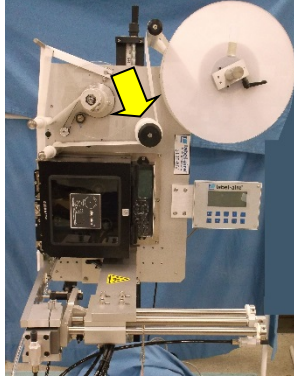
NO	PART NO.	DESCRIPTION	QTY	ASSEMBLY PHOTO	DETAIL PHOTO
39	7701354	LGT STK 50MM RED MOD STDY	1		
40	0031016	ASY/WRNG CBL PROD DET	1		
41	0031024	ASY/WRNG CBL KB/DSPL INTL	1		
42	7465516	ASY CBL APPL PORT ZEBRA	1		

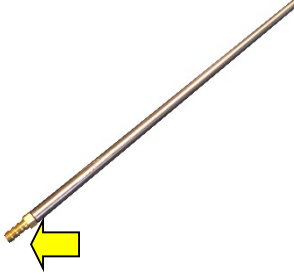

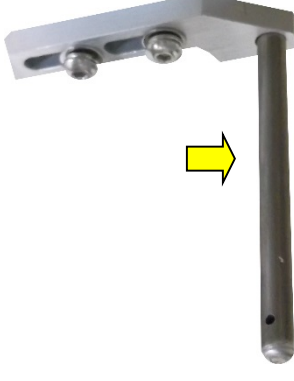

**M236000-3138NV SPARE PARTS
CIRCUIT BOARDS & ELECTRICAL**

NO	PART NO.	DESCRIPTION	QTY	ASSEMBLY PHOTO	DETAIL PHOTO
43	7465517	CABLE APPL PORT DATAMAX/SA	1		
44	7465525	ASY CBL USER OUTPUT	1		
45	0031021	ASY/WRNG CBL STROBE OUT	1		
46	7465524	ASY CBL RS232 PRINTER	1		
47	3306212	PANEL I/O ELECT	1		



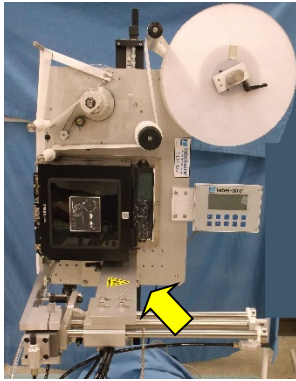
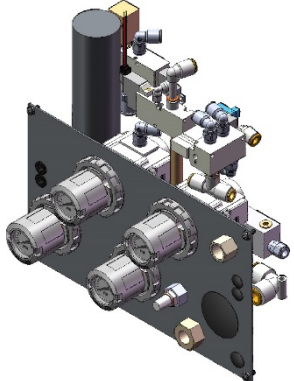
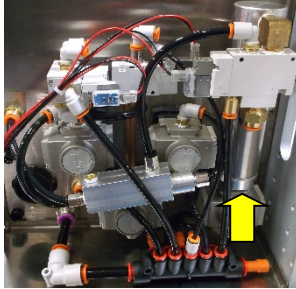

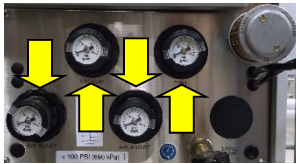

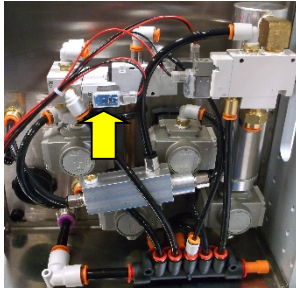
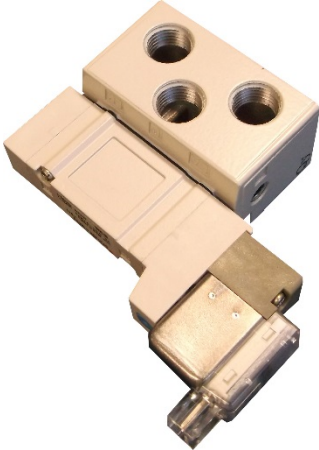

**M236000-3138NV SPARE PARTS
MECHANICAL PARTS**

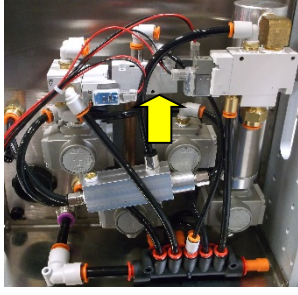
NO	PART NO.	DESCRIPTION	QTY	ASSEMBLY PHOTO	DETAIL PHOTO
48	3306280	ASY ROLLER 2" 3138NV	1		
49	7480660	FTG BARB 1/8 10-32 MALE (AIR ASSIST)	1		
50	7422287	TUBE AIR ASSIST 9" 0.25 DIA	1		
51	3301259	BRKT AIR ASSIST	1		
	7100573	SCREW BHSC #8-32X0.625	2		
	7101676	WASHER FLAT #8	2		
	7436300	WASHER SPLIT LOCK #8	2		
	7100021	SCREW SHC #4-40X0.500	1		

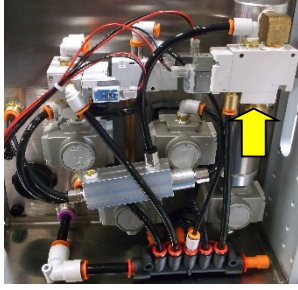

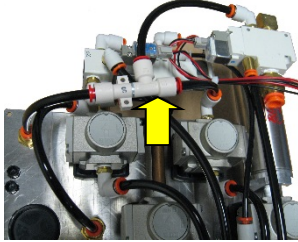

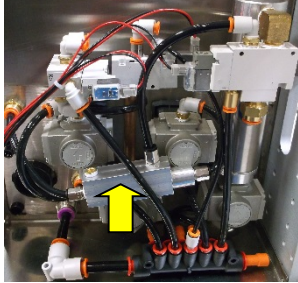
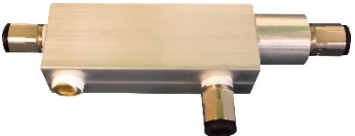
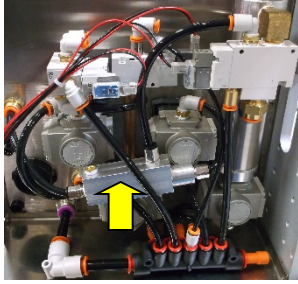
**M236000-3138NV SPARE PARTS
MECHANICAL PARTS**

NO	PART NO.	DESCRIPTION	QTY	ASSEMBLY PHOTO	DETAIL PHOTO
52	3306196	ASY PNEU 3138NV 4 STATION	1		
53	7484603	ACCUM 1/4 NPT	1		
54	7702120	REGULATOR GUAGE IN KNOB 1/8NPT	4		
55	7702207	VALVE 4 WAY IN LINE 24 VDC (TAMP)	1		



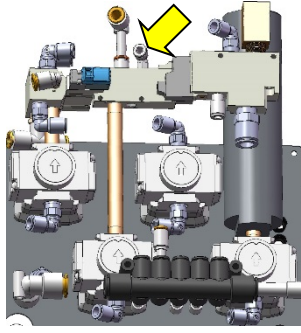
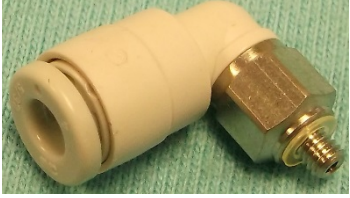
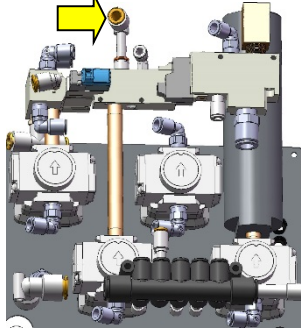

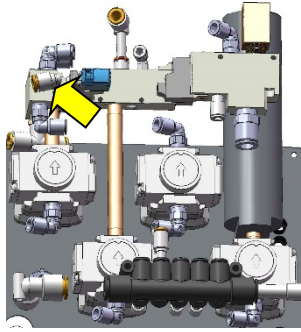

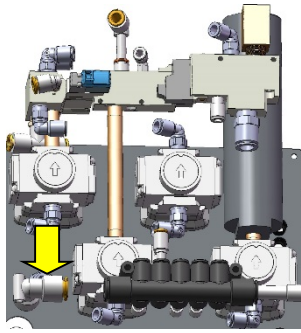
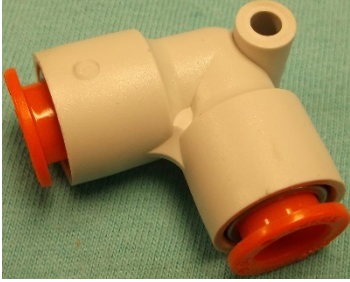

**M236000-3138NV SPARE PARTS
MECHANICAL PARTS**

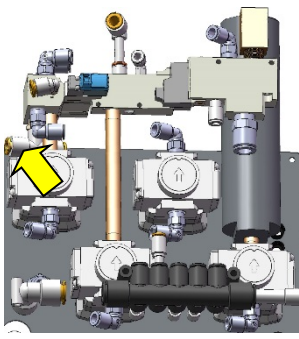
NO	PART NO.	DESCRIPTION	QTY	ASSEMBLY PHOTO	DETAIL PHOTO
56	7702208	VALVE 3 WAY IN LINE 24 VDC (AIR ASSIST)	1		
57	7702209	VALVE 3 WAY IN LINE 24 VDC (AIR BLAST)	1		
58	7702259	VACUUM EJECTOR 1/4 TUBE (REPLACED BY P274500)	1		
59	P274500	F/KIT VAC TRANSDUCER UPGRADE	1		
60	7453311	VAC TRANSDUCER (WITHOUT FITTINGS)	1		

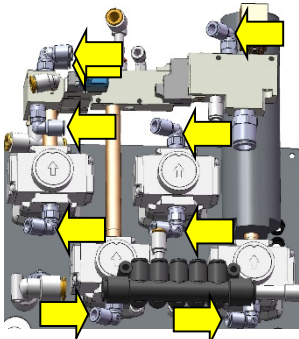

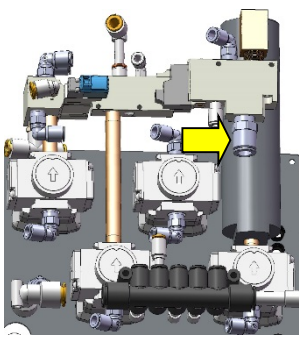

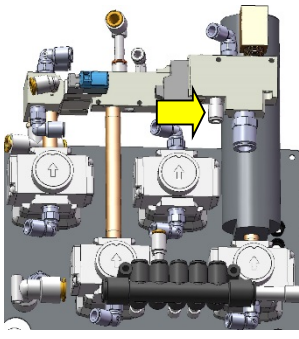

**M236000-3138NV SPARE PARTS
MECHANICAL PARTS**

NO	PART NO.	DESCRIPTION	QTY	ASSEMBLY PHOTO	DETAIL PHOTO
61	7702218	FTG TUBE ELBOW M3 X 5/32	1		
62	7702219	FTG PLUG-IN ELBOW 1/4 TUBE	1		
63	7702236	FTG PLUG-IN ELBOW TUBE M5 X 1/4	1		
64	7702255	FTG 3/8 TUBE UNION ELBOW	1		

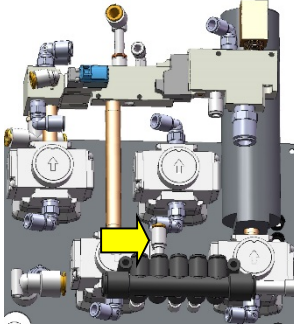

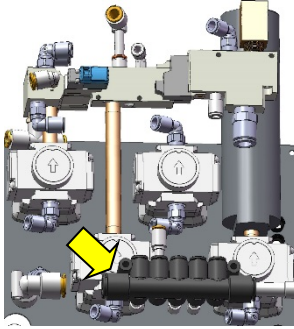
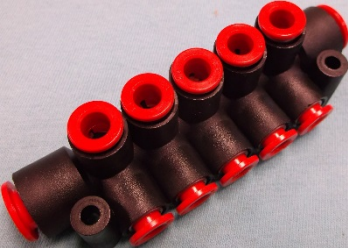
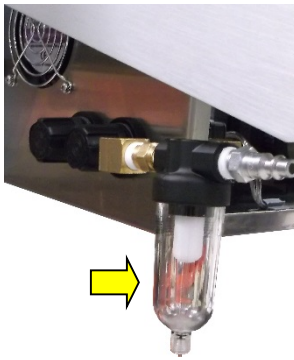
**M236000-3138NV SPARE PARTS
MECHANICAL PARTS**

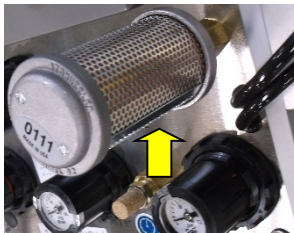
NO	PART NO.	DESCRIPTION	QTY	ASSEMBLY PHOTO	DETAIL PHOTO
65	7702256	FTG 1/8 NPT X 1/4 TUBE TEE	1		
66	7707286	FTG ELB/S 1/8 MNPT 1/4 TUBE PO	9		
67	7707287	FTG CNCTR 1/4 MNPT 3/8 TUBE PO	1		
68	7703168	FTG CNCTR M5 5.32 TUBE PO	1		

**M236000-3138NV SPARE PARTS
MECHANICAL PARTS**

NO	PART NO.	DESCRIPTION	QTY	ASSEMBLY PHOTO	DETAIL PHOTO
69	7702213	ADAPTER 1/4T TO 5/32T	1		
70	7702257	FTG MFLD 10 OUTLET ONE TOUCH	1		
71	7481900	FILTER 1/4 NPT	1		
72	7452508	MUFFLER EXHAUST 1/4 MNPT SHORT	1		

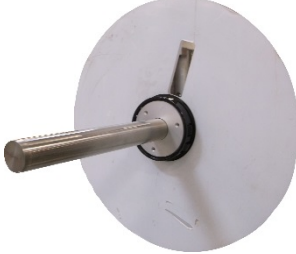
**M236000-3138NV SPARE PARTS
MECHANICAL PARTS**

NO	PART NO.	DESCRIPTION	QTY	ASSEMBLY PHOTO	DETAIL PHOTO
73	7452500	MUFFLER EXHAUST 1/4 NPT SNTR	1		
74	3302015	PIN LOCKING RWD 7" MOD (CANDY CANE)	1		
75	3300703SP	ASY ROLLER 1.25X 8.25 SE CLR	1		
76	3306288	ASY INNER UNWD DISK 12"	1		

M236000-3138NV SPARE PARTS					
MECHANICAL PARTS					
NO	PART NO.	DESCRIPTION	QTY	ASSEMBLY PHOTO	DETAIL PHOTO
77	3306289	ASY OUTER DISK 12" W/MTG BLK AND KIP HANDLE	1		
78	7702131	DISK HANDLE	1		
79	7212010	COLLAR GUIDE (2" DIA ROLLER)	2		
80	7001540SP	COLLAR GUIDE 0.75 X 0.37 WIDE	3		

**M236000-3138NV SPARE PARTS
MECHANICAL PARTS**

NO	PART NO.	DESCRIPTION	QTY	ASSEMBLY PHOTO	DETAIL PHOTO
81	3305025	SENSOR FLAG	1		
82	7482401	TUBING 1/4 (AIR ASSIST) (SOLD BY THE INCH)	in		
83	7700589	TUBING 3/8 (AIR SUPPLY, TAMP) (SOLD BY THE INCH)	in		
84	7700584	TUBING 1/4 BLACK (AIR CYLINDAR) (SOLD BY THE INCH)	in		
85	7700951AP	RETRO PRODUCT DETECTOR REFLECTOR TAPE (1" W X 4.5" L)	1		